

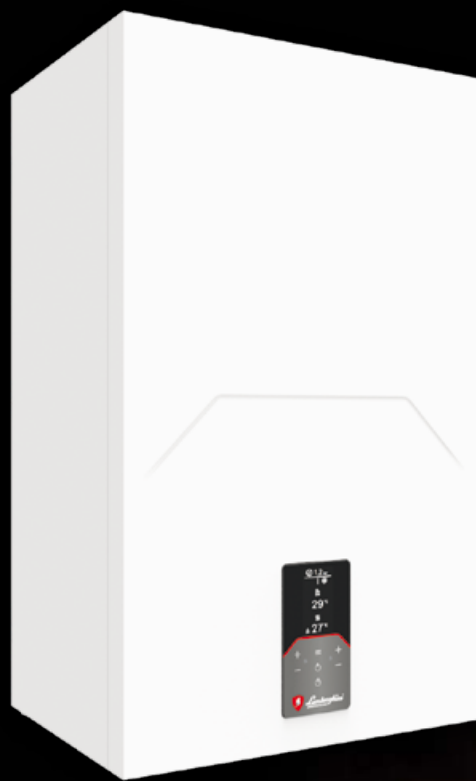

Lamborghini
CALORECLIMA



Alhena Tech
Wall hung condensing boilers with instantaneous DHW production



ALHENA TECH...HITECH UNDER EVERY POINT OF VIEW



The new user interface with «capsense» technology, without mechanical keys and provided with 2.8" graphical display, allows the user to conveniently and simply interact with the product.

Thanks to the **space heating energy efficiency η_s 94%** among the highest in the category (Classe A ErP, scale from G to A++) and to the **Connect** remote control coupling, capable of reading the outdoor temperature directly from the Internet, **it reaches system energy class A+** (scale from G to A+++). It easily adapts to the load conditions thanks to the **broad modulating range** that can reach 1:10 (1:10 mod. 34 C, 1:9 mod. 28 C, 1:7 mod 24 C).

Thanks to the **"Hydrogen plug-in"** system, one of its most important innovations, it is capable of self-adjusting to operate with natural gas and hydrogen mixtures, which will soon arrive in Europe, to **counter global warming**.

Designed to fully meet the requirements of a **«robust» product under every point of view** thanks to the **high-pass primary heat exchanger which guarantees maximum efficiency and long-lasting reliability** also, but not only, replacing old generators in particularly soiled installations.



THE RANGE

models operating with both natural gas and LPG

mod. C

mod. 24 C

COMBINED (14 l/min at Δt 25°C)

mod. 28 C

COMBINED (16.1 l/min at Δt 25°C)

mod. 34 C

COMBINED (19 l/min at Δt 25°C)

mod. H

mod. 28 H

HEATING ONLY
(Max heat input 27.2 kW)

mod. 34 H

HEATING ONLY
(Max heat input 30 kW)

mod. 45 H

HEATING ONLY
(Max heat input 43.9 kW)

AS SILENT AS CAN BE

FOR MAXIMUM COMFORT AT HOME



The detailed design of ALHENA TECH has made it possible to achieve significant values in terms of **silence and acoustic comfort**, thereby making it almost difficult to distinguish the background noise of a home from the noise produced by the boiler during normal operation.

The **on/off transistors have also been optimised according to acoustic comfort** so that the user will have a hard time knowing whether the boiler is on or off by its noise, as in old-generation boilers.

Even the design has been taken care of, creating a precious removable 3-piece casing that extends to cover the pipe connections.

ALHENA TECH

VIEW FROM INSIDE

EXCHANGER

Stainless **steel high-pass single-circuit**, exchanger, clog-resistant and easy to clean

BURNER

Exclusive **special stainless steel** semi-spherical burner **with long-life gasket**

BURNER HOLDER

Self-cooling burner holder without insulating panel

GAS ADAPTIVE

Intelligent **"Gas-adaptive"** system derived from industrial boilers, which monitors and self-stabilises combustion, based on gas + flue gas conditions

FAN

Offset fan, to make **maintenance easier on the thermal unit without taking it down.**

Built-in flue gas backflow valve for connection to C.C.S. (compliant with UNI 7129)

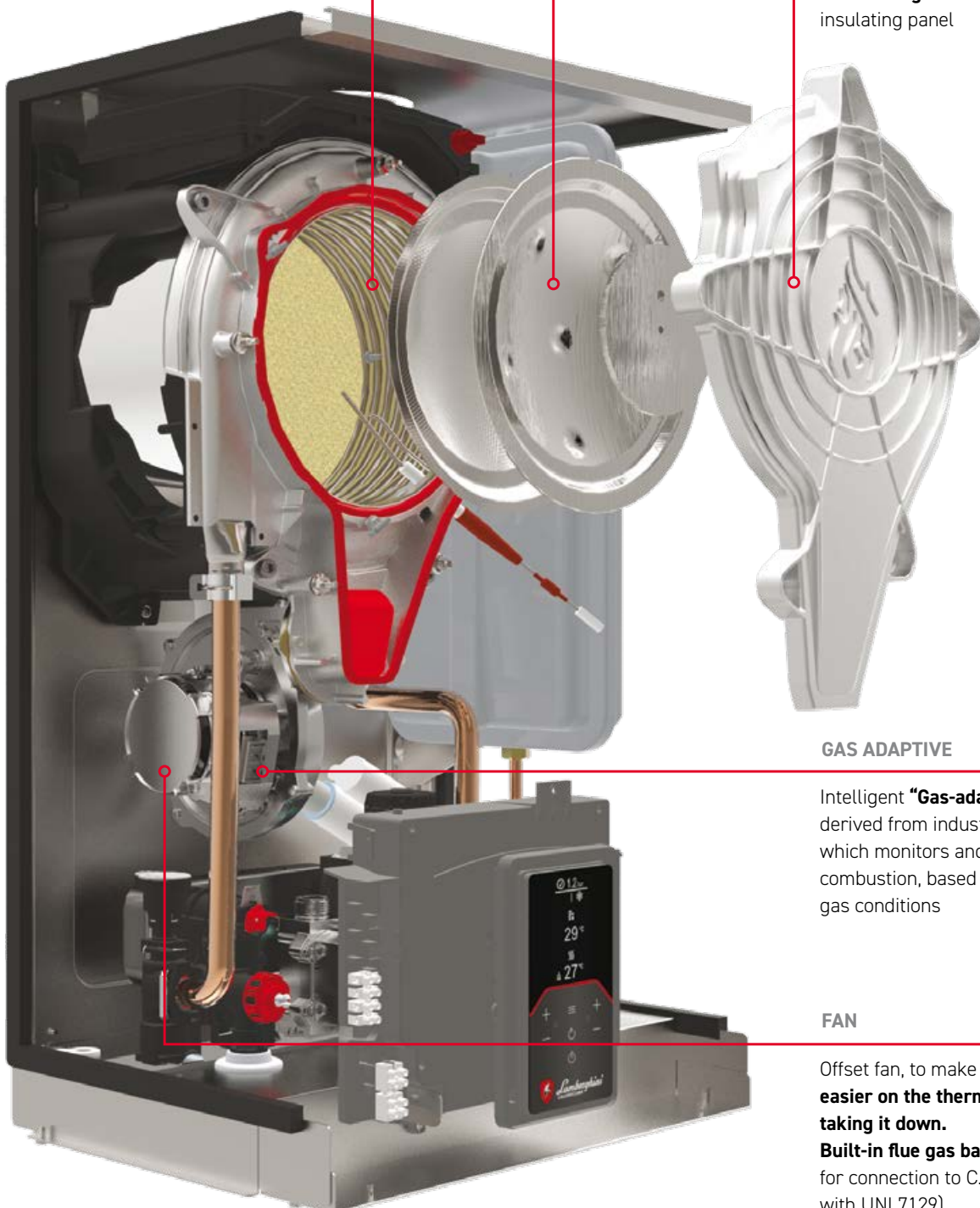

CHARACTERISTICS

PRODUCT BENEFITS

- > **Boiler** with high thickness stainless steel primary heat exchanger, with large passes (the largest in the category) guaranteeing duration and reduced maintenance, it maintains high efficiency even on old systems with oxidation and soiling
- > **A+ SYSTEM**: being combined with the **CONNECT** modulating remote control, and the outdoor temperature reading directly from the internet, it reaches the **maximum energy efficiency** * (scale from G to A+++)
- > **Class 6 NOx**: already in compliance with the requirements of the ErP regulation of 26.09.2018 (NOx emissions < 56mg/kWh)
- > **MC²**: Multi Combustion Control, new combustion system with industrial-derived gas-adaptive patented technology for better adaptability of use to the varying gas network conditions (e.g. pressure fluctuations or drops)
- > **M.G.R.**: Methane LPG Ready, with a simple configuration the boiler can run on methane or LPG without using additional conversion kits
- > Exclusive exchanger-burner system with self-cooling door: it simplifies maintenance and lowers the cost thanks to a lower number of consumable parts
- > **Instantaneous production** of domestic hot water with a dedicated DHW plate exchanger (only for version C)
- > **Hydraulic fittings** covered by the boiler casing
- > Large **multi-purpose backlit** graphic display to set parameters easily and correctly
- > **Bypass** as per standard
- > It easily adapts to the load conditions thanks to the **broad modulating range** that can reach 1:10 (1:10 mod. 34 C, 1:9 mod. 28 C, 1:7 mod 24 C).
- > **Particularly suitable for operation in flues requiring "heavy duty" pipes thanks to approval for operation with 50mm diameter flue outlets**
- > **F.P.S.**: Flue gas Protection System. The **flue gas check valve** provided as per standard offers easy connection to pressurised collective flue systems (e.g. in restructuring), in accordance with regulation UNI 7129
- > Designed to **simplify and make normal** maintenance and cleaning **steps easier**
- > **Solar system set-up**: set up for the production of domestic hot water combined with solar panel systems
- > **ECO function** in DHW mode for more savings when hot water is not really used (only for version C)
- > **Digital flame control** with three ignition attempts if operation gets blocked due to failed flame detection (only in natural gas mode)
- > **Place of installation**: also outdoors, in a partially protected place down to -5°C as per standard and even -15°C with the addition of the optional antifreeze heaters kit

THE PRODUCT IN BRIEF



Exclusive integrated Lamborghini CaloreClima "Thermobalance"™ thermal unit



Operating with **natural gas mixtures enriched with hydrogen** already provided for distribution in Europe (*)

(*) mixtures of Natural Gas/Hydrogen 80%/20%



EXCHANGER STAINLESS STEEL
Stainless steel high performance mono-thermal primary exchanger

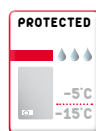

PROTECTED
Operation in a **partially protected location** with a minimum temperature of **-5°C for the standard version** and, if fitted with the antifreeze kit, even temperatures down to **-15°C**



EASY MAINTENANCE
This equipment is designed specifically to offer **particularly simple** installation and maintenance



RANGE
Modulating ratio between **Pmax** and **Pmin**



MODE
The appliance can be combined with **preheating** systems for domestic hot water



CLIMATIC
Device operating with **climatic control** and sliding system temperature (optional outdoor temperature probe)



REMOTE
Remote control of boiler parameters via remote control



STOP AND GO
You can **delay burner ignition** by starting it up only when domestic hot water is actually drawn



METHANE LPG READY
M.L.R.: Methane LPG Propane-air Ready, with a simple configuration, the boiler can run on methane or LPG without using additional conversion kits



ETA 94%
It reaches one of the highest seasonal space heating efficiencies in its category: η_s **94%**



COLLECTIVE PRESSURISED
F.P.S.: Flue gas Protection System. The flue gas check valve can be **easily connected to the pressurised flue collective systems** (e.g. restructuring), in accordance with regulation UNI 7129



MULTI COMB. CONTROL
MC²: Multi Combustion Control, new combustion system with patented gas-adaptive technology



FLUE GAS 50 mm
Approved for operation with **50mm diameter flue gas discharge**



RANGE RATED
Appliance certified as "**range rated**" according to EN 483

BOILER CONTROL

CONTROL BOARD AND FUNCTIONS

The new user interface with «capsense» technology, without mechanical keys and provided with 2.8" graphical display, allows the user to conveniently and simply interact with the product, thus customising operation of the appliance to control room comfort according to one's needs.



Thanks to the **remote connection via bus** this can even be done directly from the CONNECT remote control, also using your smartphone.

The boiler is also designed to connect a **second room thermostat** on terminals dedicated to manage multi zone installations.



KEY 1 Key to decrease DHW temperature setting **2** Key to increase DHW temperature setting **3** Key to decrease heating system temperature setting **4** Key to increase heating system temperature setting **5** Display **6** Back key **7** "Winter", "Summer", "Appliance OFF", "ECO", "COMFORT" mode selection key **8** Eco mode indication **9** DHW mode indication **10** Summer/Winter mode indication **11** Menu / confirm key **12** System pressure indication **13** Heating mode indication **14** Burner on indication

CONNECT

REMOTE CONTROL

- Remote control supplied with the A+ product kit to **manage comfort in the home also from Smartphone**
- It can manage **until 8 zones** by additional control units
- **Connection to the home Wi-Fi network** through the supplied RF/WiFi receiver
- CONNECT APP available for switching the boiler on and off and **managing home comfort** for heating/DHW via remote control from Smartphone (iOS and Android)
- **Maximisation of ambient comfort** with modulating regulation of the flow temperature through the **Ambient Climatic Compensation (ACC)** differentiated for each zone and **Outdoor Climatic Compensation (OCC)** through **outdoor temperature detected directly from the Internet** (or from an optional outdoor probe)
- **Improves ambient heating medium seasonal efficiency by +4%**
- **Weekly hourly programming in 30-minute intervals** via APP CONNECT
- **Operating mode:** Off, Holiday, Automatic, Manual
- **Three modifiable temperature levels:** Comfort, Economy, Antifrost



Control



RF/Wi-Fi receiver

MULTIZONE MANAGEMENT

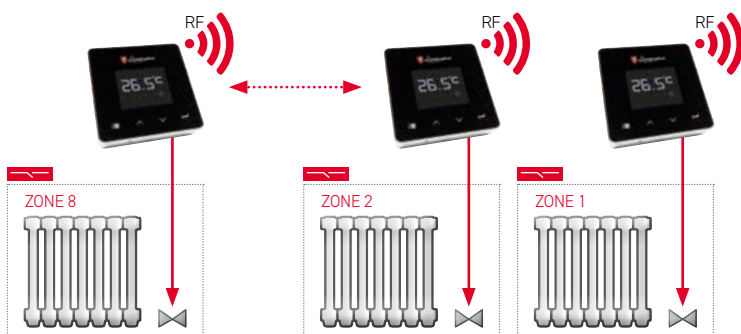

CLIMATIC COMPENSATION

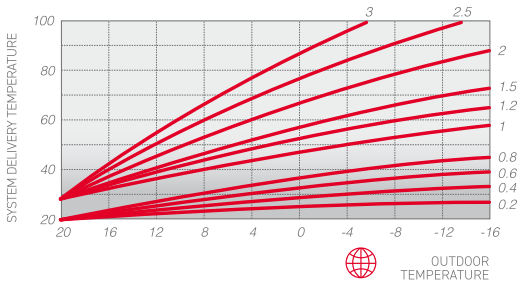

OCC | WEB | OUTDOOR AIR CLIMATIC COMPENSATION

By reading the outdoor temperature directly from the Internet (or from the optional outdoor probe), the system can change the temperature based on the outdoor temperature measured according to the climatic curves set, thus ensuring maximum user ambient comfort as the outdoor climate conditions change.

ACC | AMBIENT CLIMATIC COMPENSATION

The modulating function of CONNECT allows the boiler's power to be modulated as the value of the set room temperature is reached. This improves the quality of comfort by eliminating heat peaks with consequent energy savings.

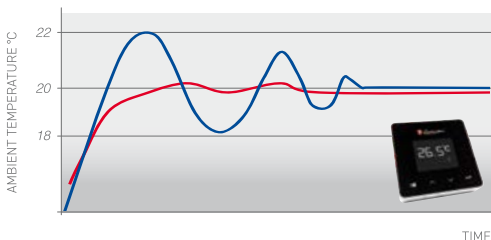

WITH CONNECT REMOTE CONTROL TIMER
WITH NON-MODULATING AMBIENT THERMOSTAT

THE MOTOR

COMBUSTION CHAMBER

The pipe used in the ALHENA TECH heat exchanger is made of **stainless steel**, a material that creates an **extremely smooth surface**, thereby less affected by scaling and deposits.



Increased extra section, the smooth surface and coil section drastically reduce the percentage of deposits inside the pipe and considerably increase the service life of the heat exchanger

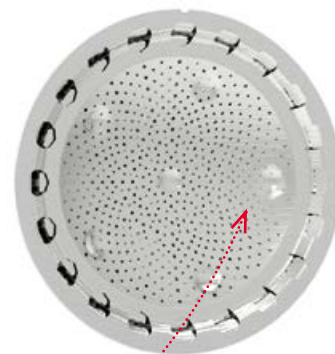
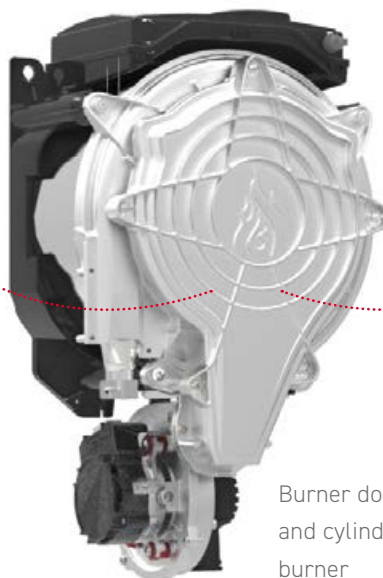

Fan with air-gas pre-mixing unit

Burner door with insulating panel and cylindrical stainless steel burner

AS EFFICIENT AS CAN BE

ALSO ON OLD SYSTEMS (REPLACEMENTS)

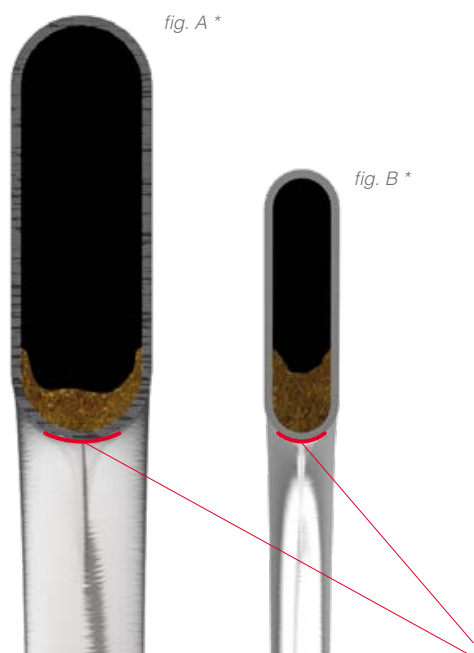

fig. A *

fig. B *

The ALHENA TECH (**fig. A**) thermal unit heat exchanger compared to the more classic and popular steel exchanger (**fig. B**).

This shape enables the heat exchanger to work at almost maximum design efficiency, even in partially clogged conditions, whereas with the same amount of deposits and sediment (e.g. due to installation on old systems), the heat exchanger in **fig. B** tends to get clogged more quickly in the part in contact with the flame as a result of the reduced fluid flow area, where an actual barrier of deposits * forms obstructing the heat exchange and reducing the efficiency to below nominal values.

* Ref.: same amount (5 gr.) of scaling and deposits in heat exchanger (A) and (B), with the same pipe length section. Scale 150% of the actual measurement.

Heat exchange section with a flame

MC²

MULTI COMBUSTION CONTROL

The electronic device controls the flame ionisation current in order to ensure **perfect combustion** according to the change in air density or gas quality. The ratio between the air/gas flow (λ) and the flame ionisation signal is used to control the air-gas ratio and, therefore, combustion. **MC²: Multi Combustion Control**, the new combustion system with **gas-adaptive** patented technology for better adaptability of use to the varying gas mains conditions (e.g. pressure fluctuations or drops).

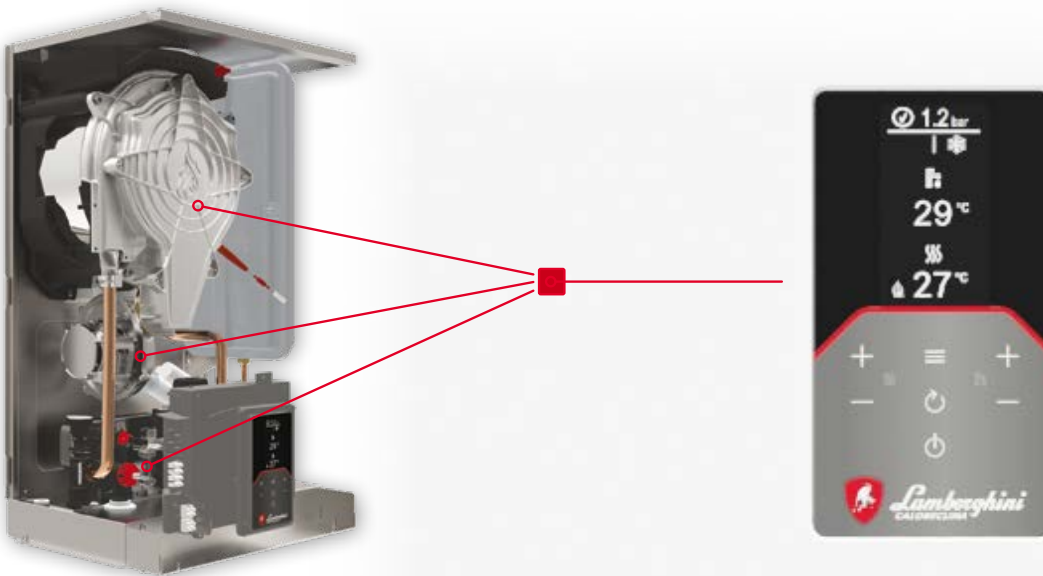

EASY MAINTENANCE

PROBLEM-FREE MAINTENANCE

When servicing the device for the first time, technicians can appreciate the care with which each part has been designed to facilitate their work. As a result of easy access to the main components, the “**Thermobalance**”™ thermal unit enables maximum accuracy and fast maintenance. A few examples:

- Internal access is facilitated by a **3-piece casing** with removable sides.
- The electric box of the electronic board can be easily removed from the chassis, giving **free access to the internal parts**.
- The **fan offset from the burner** is situated underneath and must not be removed in order to access the steel burner-heat exchanger.
- The **burner's door** is fully **air-cooled** automatically and does not require an insulating panel, thereby avoiding the risk of it getting damaged or breaking when being removed for cleaning.
- The **burner is removed by only unscrewing 3 bolts**, giving free access to the stainless steel heat exchanger.
- The **extra-increased pass heat exchanger** is designed to challenge extremely hard water conditions and can be **easily cleaned** thanks to the non-manifold single pipe circuit.
- The DHW **inlet filter** can be easily **removed** directly from the inside, **without having to remove the boiler water connections**.
- Disassembly and **replacement of the plate heat exchanger** is carried out easily **by removing the two hex bolts** that can be accessed from the front



SIMPLIFIED REPLACEMENT

FLUE EXHAUST Ø 50 MM

The new boiler can also be installed with 50 mm diameter outlets.

Particularly important in the **replacement market** in the frequent case of collective flues that require “heavy” pipes, where it is necessary to have a **high flue gas ejection capacity** also with small diameters.

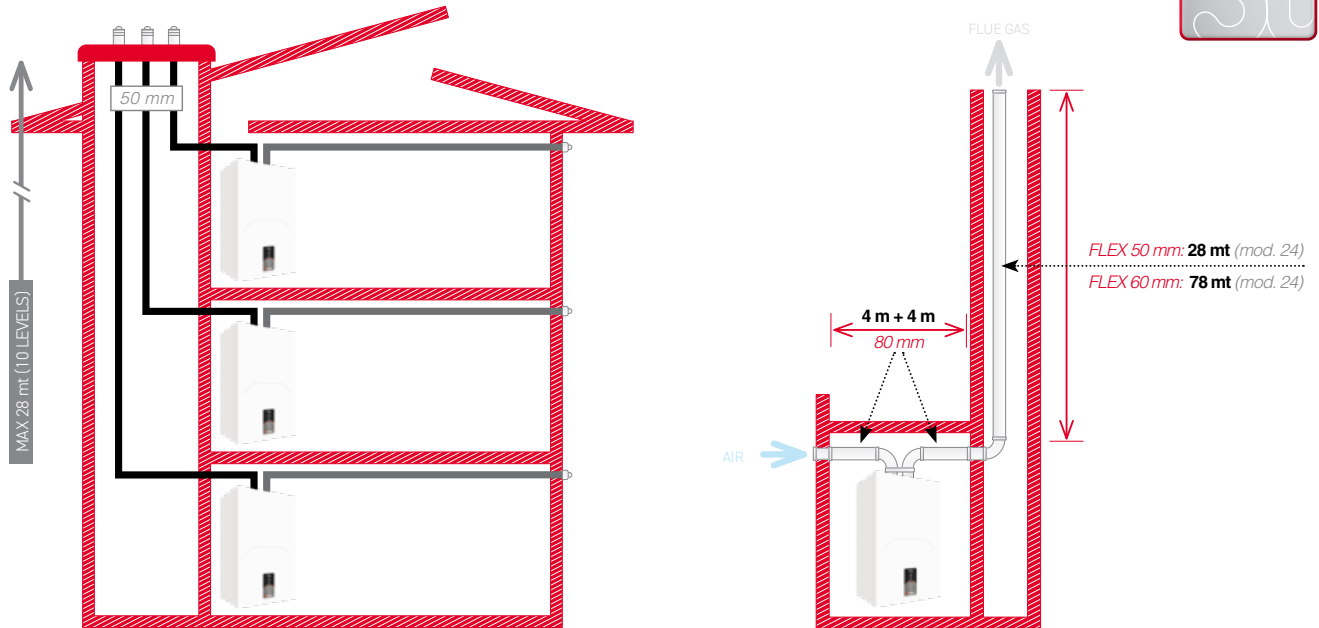

COLLECTIVE PRESSURISED

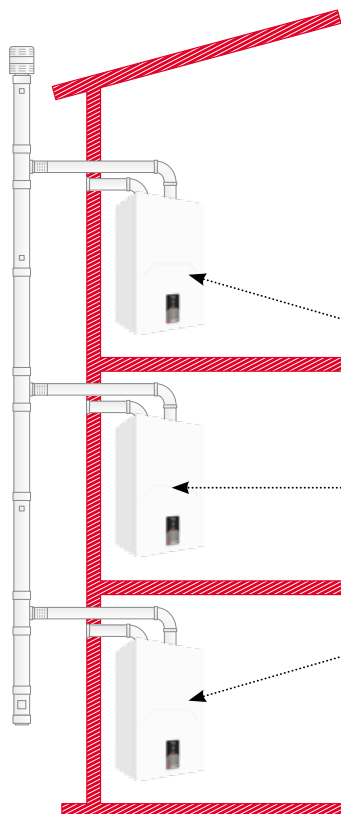

F.P.S.: Flue gas **P**rotection **S**ystem). The flue gas check valve (standard installation) offers **easy connection to pressurised collective flue systems** (e.g. in restructuring), in accordance with regulation UNI 7129. **For other installers**, the solution of pressurised collective flue gas **is more cost effective** (decrease in the diameter of the chimneys).

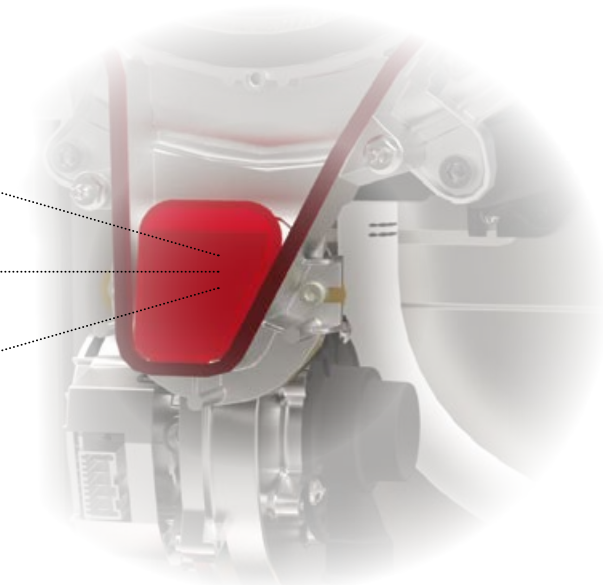

NEW LAMBORGHINI FAMILY LINE

A COMPLETE RANGE



ALHENA
24C - 28C - 34C



ALHENA TECH
24C - 28C - 34C - 28H - 34H - 45H



ALHENA TECH K 50
28 - 34



RAGGIO
28C - 34C



COMFORT AND SAFETY

FUNCTIONS

STOP AND GO FUNCTION

The use of DHW taps with short mixing or very short supply for quick rinses involves boiler ignition procedure start-ups, which usually end immediately. These **“false start-ups”** can, over time, compromise the average service life of the product. For this reason, ALHENA TECH has been equipped with an electronic parameter that is used to delay burner ignition (Stop and Go) by only activating it with actual DHW delivery.



SUN EASY FUNCTION

ALHENA TECH was designed to be installed easily into systems built with the most innovative technologies. The SUN EASY system is equipped with electronics that **simplify operation with solar panels**, both with natural and forced circulation. A sensor situated on the DHW circuit constantly controls the pre-heated water temperature from the solar panels, providing burner ignition only if the said temperature drops below the level required to ensure optimal user comfort.



DHW ECO-COMFORT FUNCTION

With ECO operation, DHW production is provided according to traditional standards, enabling energy saving when it is not used. As a result of the special temperature maintenance of the heat exchanger, **DHW supply is even faster and more comfortable** with COMFORT operation. Reaching the maximum certified 3-star comfort (EN 13203). The efficiency and load profiles according to the ErP directive are at the top of the category: **mod. 24 / 28 C / A - XL | mod. 34 C / A - XXL**



CHARACTERISTICS

HYDRAULICS - ENERGY LABEL

MOD. C

MOD. 28 - 34 H

MOD. 45 H

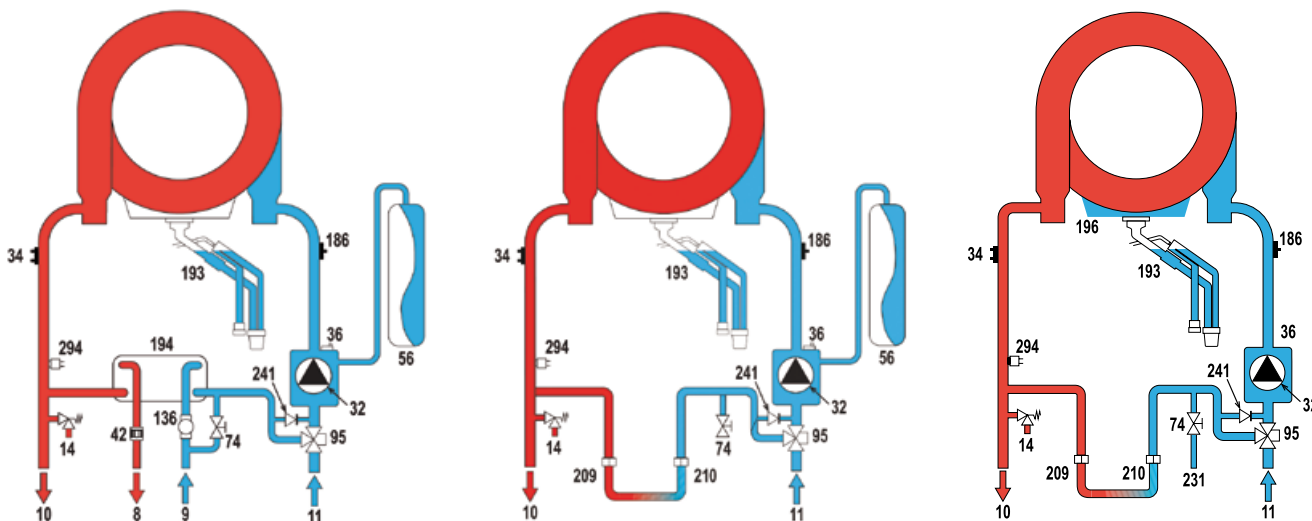

KEY 8 DHW outlet 9 DHW inlet 10 System delivery 11 System return 14 Safety valve 32 Heating circulator 34 Heating temperature sensor 36 Automatic air vent 42 DHW temperature sensor 56 Expansion vessel (mod. 45 H is supplied without the expansion vessel) 74 System filling tap 95 Diverter valve 136 Flowmeter 186 Return sensor 193 Siphon 194 DHW heat exchanger 241 Automatic bypass 294 System pressure sensor

MOD. C

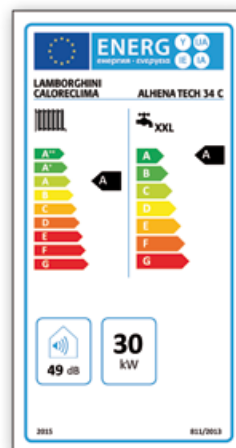
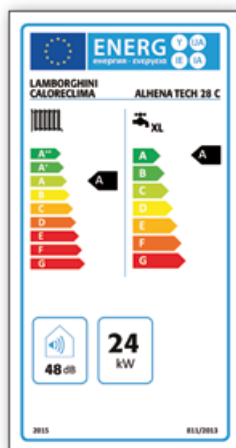
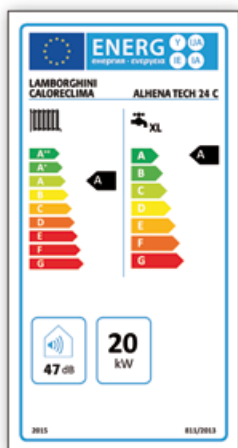

MOD. H

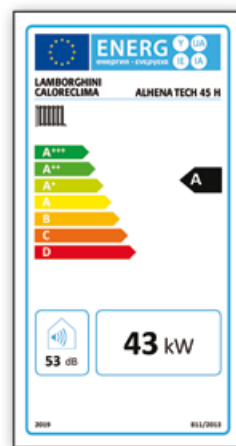
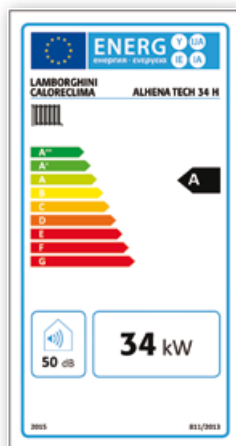
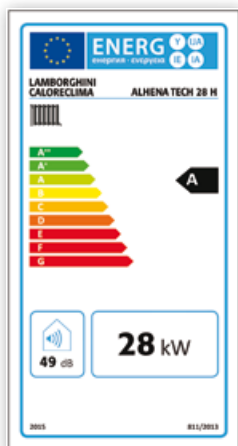

TECHNICAL DATA

DIMENSIONS

ALHENA TECH 24-28-34 C

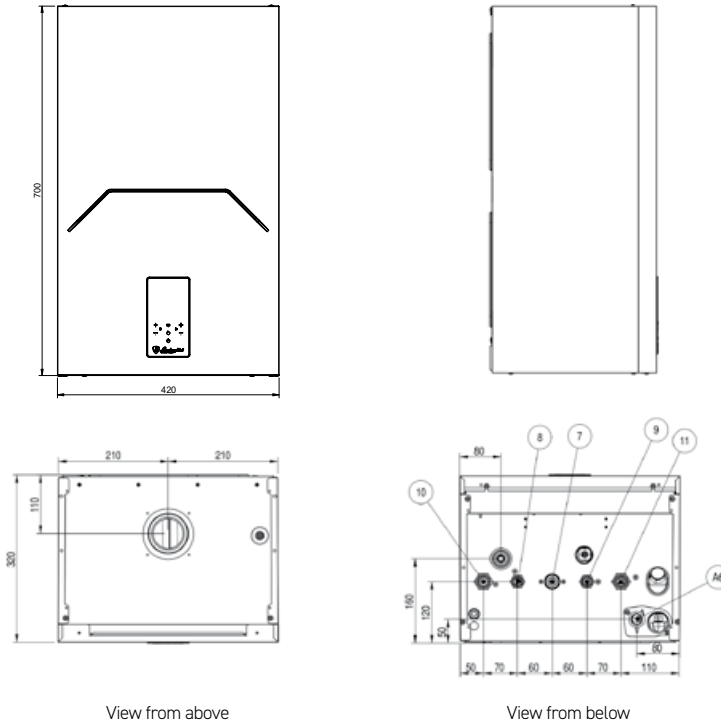

KEY 7 3/4" gas inlet 8 1/2" DHW outlet 9 1/2" DHW inlet 10 3/4" system delivery 11 3/4" system return A6 condensate discharge connection

ALHENA TECH 28-34-45 H

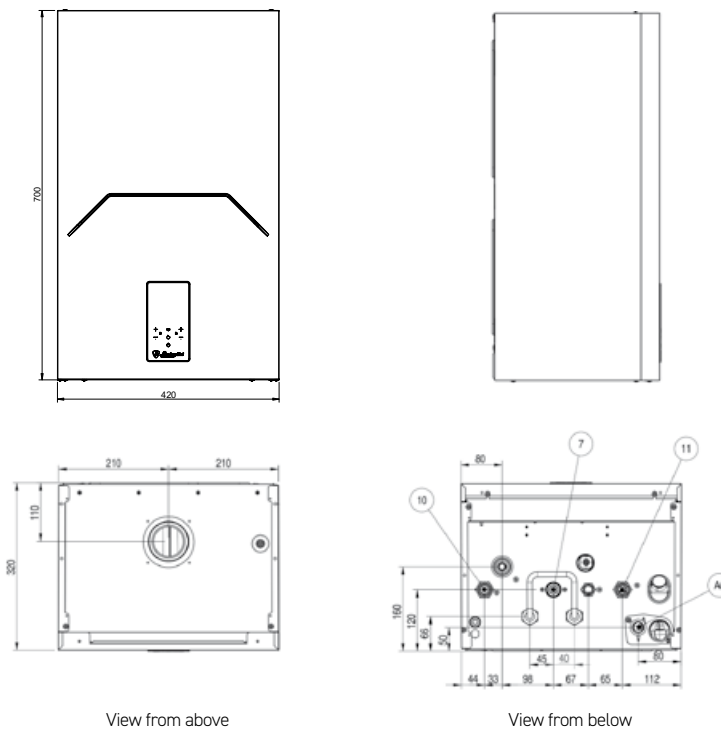

TECHNICAL DATA

PRESSURE DROPS/HEAD

ALHENA TECH MOD. 24 / 28 C

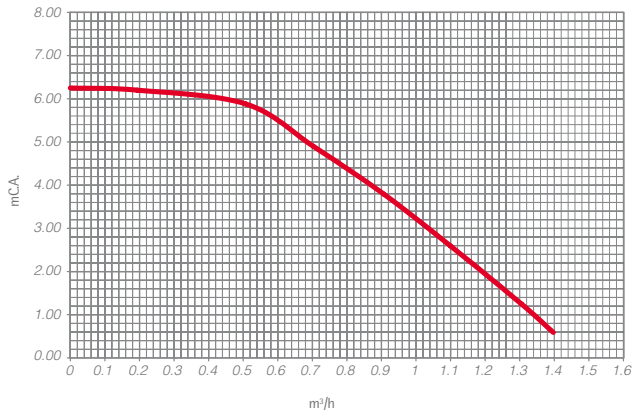

ALHENA TECH MOD. 34 C

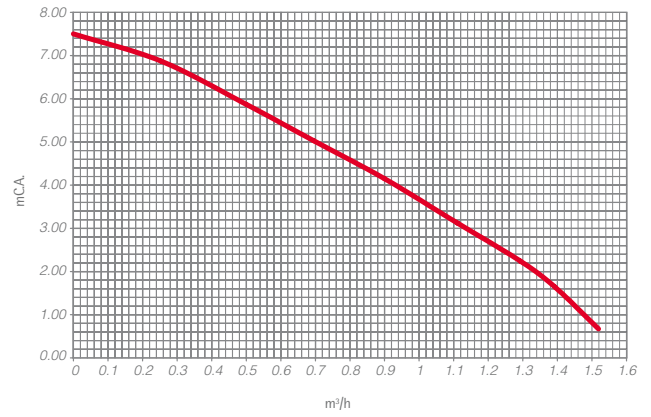

ALHENA TECH MOD. 28 H

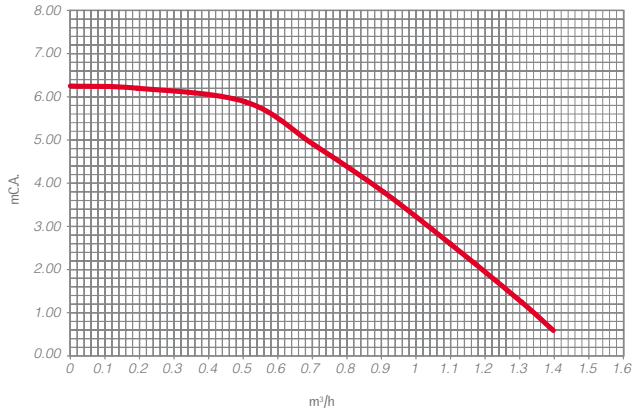

ALHENA TECH MOD. 34 H

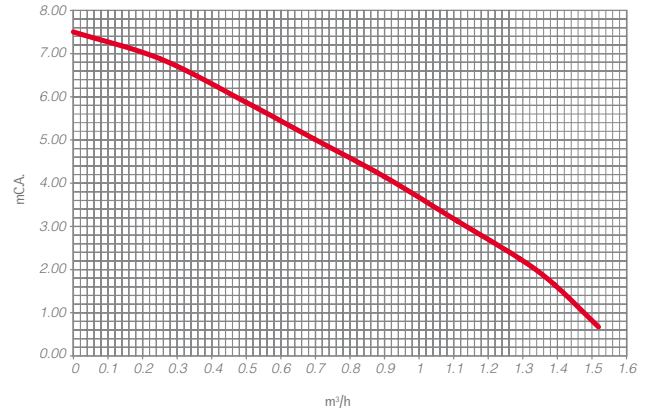



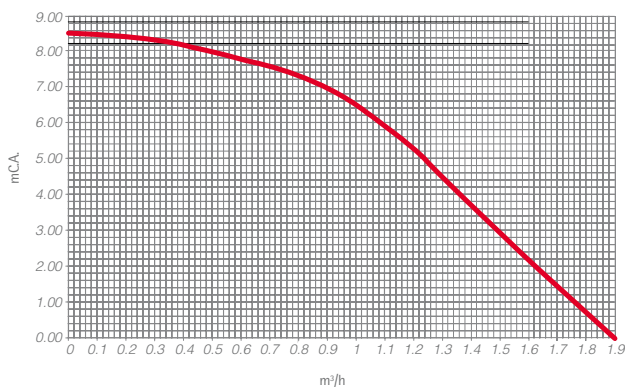











ALHENA TECH MOD. 45 H



TECHNICAL DATA

SUMMARY TABLE

ALHENA TECH		24 C	28 C	34 C	28 H	34 H	45 H
ERP Class	 (Class G - A ⁺)						
	 (Class G - A)	 	 	 	-	-	-
Heating max/min heat input	kW	20.4 / 3.5	24.5 / 3.5	30.6 / 3.5	28.5 / 3.5	34.7 / 3.5	43.8 / 6.4
Heating max/min heat output (80/60°C)	kW	20.0 / 3.4	24.0 / 3.4	30.0 / 3.4	27.9 / 3.4	34.0 / 3.4	42.9 / 6.3
Heating max/min heat output (50/30°C)	kW	21.6 / 3.8	26.0 / 3.8	32.5 / 3.8	30.2 / 3.8	36.8 / 3.8	46.5 / 6.9
DHW max heat input	kW	25.0	28.5	34.7	-	-	-
DHW min heat input	kW	3.5	3.5	3.5	-	-	-
DHW max/min heat output	kW	24.5 / 3.4	28.0 / 3.4	34.0 / 3.4	-	-	-
Pmax efficiency (80-60°C)	%	98.1	98.1	97.9	98.1	97.9	97.8
Pmin efficiency (80-60°C)	%	98.0	98.0	98.0	98.0	98.0	98
Pmax efficiency (50-30°C)	%	106.1	106.1	106.1	106.1	106.1	106.1
Pmin efficiency (50-30°C)	%	107.5	107.5	107.5	107.5	107.5	107.6
Efficiency 30%	%	109.7	109.7	109.5	109.5	109.5	109.6
G20 supply gas pressure	mbar	20	20	20	20	20	20
G20 max gas flow rate	m ³ /h	2.65	3.02	3.67	3.02	3.67	4.63
G20 min gas flow rate	m ³ /h	0.37	0.37	0.37	0.37	0.37	0.68
CO ₂ max / min G20	%	9.4 / 9.2	9.3 / 9.2	9.3 / 9.2	9.3 / 9.2	9.3 / 9.2	9.0 / 8.9
G31 supply gas pressure	mbar	37	37	37	37	37	37
G31 max/ min gas flow rate	kg/h	1.94 / 0.27	2.21 / 0.27	2.70 / 0.27	2.21 / 0.27	2.70 / 0.27	3.4 / 0.5
CO ₂ max / min G31	%	10.3 / 9.8	10.3 / 9.8	10.3 / 10.0	10.3 / 9.8	10.3 / 10.0	10.3 / 10.0
NO _x emission class (EN 15502-1)	-	6	6	6	6	6	6
Max heating working pressure	bar	3	3	3	3	3	3
Min heating working pressure	bar	0.8	0.8	0.8	0.8	0.8	0.8
Max heating temperature	°C	95	95	95	95	95	95
Heating water content	litres	2.9	2.9	4.3	2.9	4.3	5.5
Heating expansion vessel capacity	litres	8	8	10	8	10	-
Heating expansion vessel preload pressure	bar	0.8	0.8	0.8	0.8	0.8	-
DHW max working pressure	bar	9	9	9	-	-	-
DHW min working pressure	bar	0.3	0.3	0.3	-	-	-
DHW flow rate Δt 25°C	l/min	14	16.1	19.5	-	-	-
DHW flow rate Δt 30°C	l/min	11.7	13.4	16.2	-	-	-
Protection rating (IEC 60529)	IP	X4D	X4D	X4D	X4D	X4D	X4D
Supply voltage	V/Hz	230V / 50Hz	230V / 50Hz	230V / 50Hz	230V / 50Hz	230V / 50Hz	230V / 50Hz
Heating absorbed electric power	W	63	70	80	70	80	132
DHW absorbed electric power	W	73	82	99	-	-	-
No-load weight	kg	28	28	32	28	32	35



The illustrations and data provided are indicative. Lamborghini CaloreClima reserves the right to make any changes deemed to be most appropriate for the improvement of the product or of the service offered without being obliged to give prior notice.

The images in this catalogue are under copyright owned by Lamborghini CaloreClima.